



**DOD**

## Soto Sleeping Pad S/M/L

CM1-649-TN (Tan)

CM2-650-TN (Tan)

CM3-651-TN (Tan)

<https://dodoutdoors.com/>

Be Outdoors Together.



### Owner's manual

Thank you for purchasing the Soto Sleeping Pad. For your safety, please read over all instructions before use. Keep this manual in a safe place for future reference.

Please use the Soto Sleeping Pad for its intended use. To avoid harm to users, or damage to the product, please follow all safety guidelines and adhere to the precautions described below.



## **WARNING** Failure to follow guidelines and warnings may result in death or serious injury.

● **If any part of this product is found to be defective, please discontinue use immediately.**

- Using defective products may cause injury.

● **Do not use high pressure pumps, compressors, or your car's exhaust to inflate this pad.**

- This may cause the pad to explode and cause injury.

● **People who have difficulty changing their own posture (infants, those with disabilities) should not use this product.**

- Please do not jump on the pad.

● **Please do not use this product to sleep in areas known to flood or areas in the path of falling rocks.**

- Make sure the pad is placed on solid, flat ground to avoid rips, tears, and damage. Use pad on ground with good drainage.

● **Avoid the use of heat sources (lanterns, stoves, heaters, cigarettes, candles, etc.) around this product.**

- The use of a heat source may cause a fire. Also, damage to product could occur.



## **CAUTION** Please exercise caution and read below in order to minimize damage to product and risk of injury.

● **Parental supervision is strongly advised when small children use the pad.**

- Unsupervised use may cause damage to product or may lead to injury.

● **Do not apply excessive force to this product when assembling or folding.**

- If parts become damaged, there is a risk of injury.

● **Please make sure when lying down on the mattress, your weight is evenly distributed.**

- If weight is unevenly distributed, the mattress may tip over.

● **Do not use product on a hot surface.**

- Product may be damaged by heat.

● **Do not allow this product to come in contact with sharp objects.**

- This can damage the product.

● **This product is not intended for pets.**

- Pets may damage the mattress.

● **Do not leave the valve closed in a hot place such as a car during the summer.**

- This can damage the product.

● **Do not jump or step on mattress or pillow.**

- This may damage the product.

# CONTENTS:

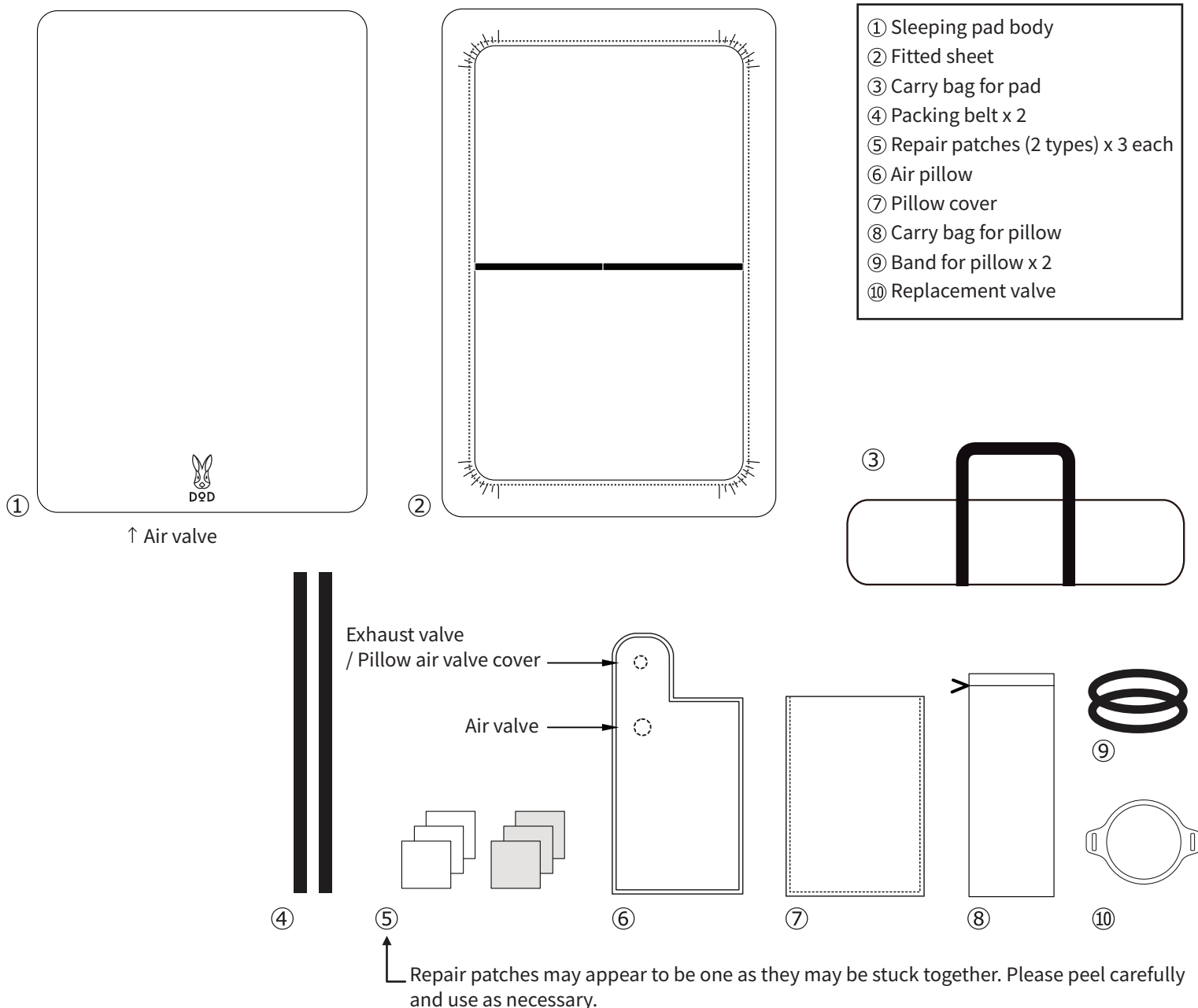

# PRODUCT SPECIFICATIONS

[Materials]	Pad fabric (front and back)	:	Polyester
	Sheet & Pillow Cover	:	20% cotton; 80% polyester
	Carry Bag	:	Polyester
	Pad inner	:	Polyurethane foam
	Packing belt	:	Polypropylene
	Pillow fabric (front and back)	:	Polyester

Made in China

## <HOW TO USE THE AIR VALVE>

\*THE PAD AND AIR PILLOW USE A COMMON AIR VALVE AND MAY BE OPERATED THE SAME WAY.

\*ROTATE THE CIRCULAR PARTS INSIDE OF THE AIR VALVE TO SWITCH BETWEEN INFLATE AND DEFLATE.

\*WHILE THE CIRCULAR PARTS MAY BE REMOVED FROM THE VALVE, IT IS IMPORTANT NOT TO REMOVE THEM.

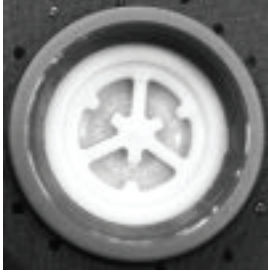
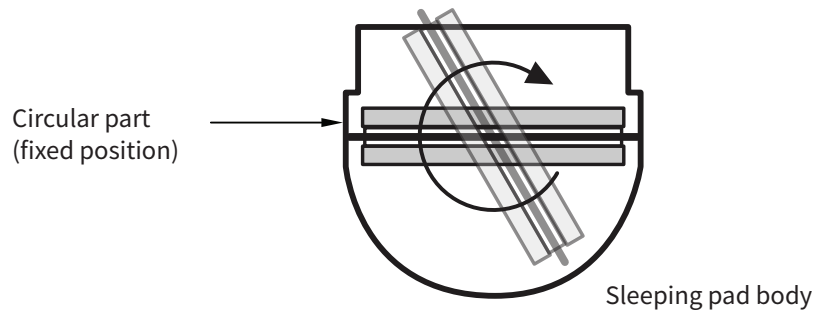

### ■ INFLATE MODE

Please only inflate the mattress with air. To keep air inside, close the cap tightly (while in inflate mode).



### ■ OPEN MODE

When the valve is in open mode, air is free to enter and exit.



### ■ DEFLATE MODE

In deflate mode, air can be expelled but not taken in. Use this mode for deflating the mattress.

## HOW TO USE:

---

1. Remove the pad body from the bag.
2. Spread the pad on the ground.
3. Set the air valve to inflate mode. Air will automatically inflate the mattress.
4. Mattress may not fully inflate during first use or use after a long time.

\*If this occurs, open the valve and let it sit for 1 to 2 hours. The use of the pillow as an air pump may become necessary.

\*The thickness of the pad varies depending on the atmospheric pressure and storage conditions.

## <HOW TO ATTACH THE FITTED SHEET>

---

1. Remove the sheet from the bag.
2. Remove the belt on the back of the sheet. Insert the pad into the sheet.

\*Insert the pad with the bottom facing you.

3. Fix the belt on the back and smooth out wrinkles.

## <HOW TO USE THE AIR PILLOW>

### [WHEN USING AS A PILLOW]

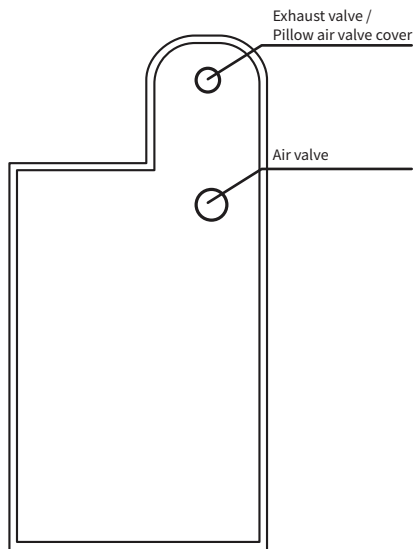

[Back of pillow]

- How to adjust the amount of air.

#### Inflating pillow

Cover the exhaust valve with your hand and blow air into the air valve in inflate mode. Snap the exhaust valve into the air valve to stop air from being released.

#### Deflating pillow

With the air valve in the deflate mode, hold the pillow and force air out. Once the pillow is fully deflated, cover the air valve.

### [WHEN USING AS MATTRESS PUMP]

1. Set the air valve on the mattress to inflate mode.
2. Set the air valve on the pillow to inflate mode.
3. Connect the exhaust valve of the pillow to the air valve on the mattress.
4. Blow up the mattress by rolling the pillow from the opposite side of the connection.  
It is recommended to blow up with the pillow pump on the ground so that you can use your body weight.

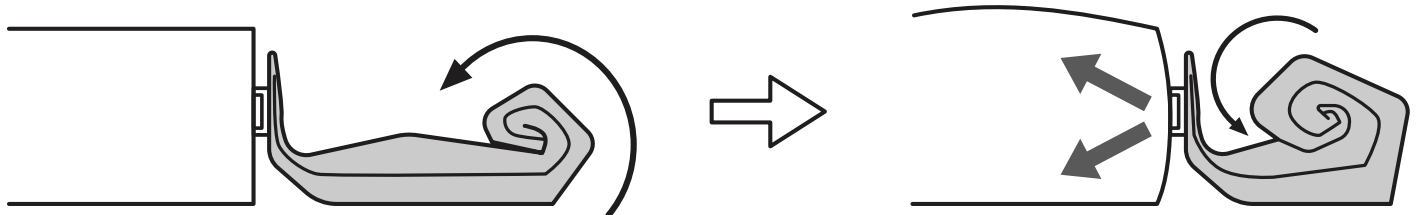

## <STORAGE>

- \* Product in image may be different but the storage method is the same.
- \* After storage, product may swell gradually due to the length of time or temperature changes. Be sure to use the packing belt provided.



1. Put the valve in open mode (or deflate mode) and place down with the air valve opposite you. Push air out while rolling up the mattress.



2. After putting the valve in deflate mode, tighten with packing belt provided.



3. Put the mattress into the storage bag with the fitted sheet and pillow.

## <HOW TO REPAIR HOLES WITH THE REPAIR SHEETS>

\*The repair sheet is intended for temporary repair only.

\*Cut the repair sheet larger than needed to cover the hole and attach flat without causing wrinkles.

### ■ Procedure:

1. Cut the repair sheet bigger than the hole so that it covers sufficiently.
2. Lightly wipe off dirt from around the hole.
3. Make sure the area is dry.
4. Apply adhesive (sold separately) to the glossy surface of the repair sheet. Place over hole and hold pressure.

\*Use urethane-based agents that do not cure after drying.

\*When using adhesive, please refer to instructions and use correctly.

## STORAGE METHOD:

- After use, remove dirt and allow pad to dry completely.  
Storing your mattress while still wet may cause discoloration, mold, corrosion, and/or deterioration. Remove dirt by wiping with a fully wrung out cloth. Allow the mattress to dry completely. Do not use organic solvents as they may cause discoloration.
- Avoid high temperature and humidity, and store in a well-ventilated place out of direct sunlight.  
Incorrect storage may cause color transfer, mold, corrosion and deterioration.
- Do not wash the mattress carry bag.
- When washing the fitted sheet or pillow cover, use mild detergent in cold water and dry on lowest heat setting.

## ADDITIONAL INFORMATION

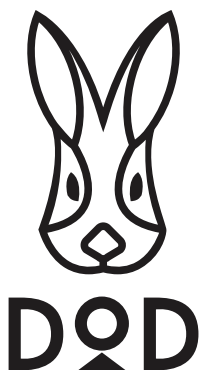

DOD helps you spend better time outdoors with friends and family. DOD is a leading outdoor gear company from Japan, developed for those who favor thoughtfulness of design, style, and quality. Our gear makes camping delightful, whether sleeping, lounging, cooking, or eating. We bring cozy outdoors.

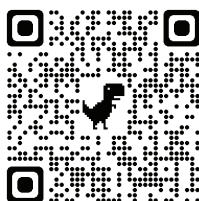

Website: <https://dodoutdoors.com/>

For general inquiries or questions about your product, please reach out to us!

Email: [info@dodoutdoors.com](mailto:info@dodoutdoors.com)